

## LATERAL STIFFNESS – STRENGTH DISTRIBUTION AND DAMAGE CONCENTRATION ALONG THE HEIGHT OF A BUILDING

Keiichi INOUE<sup>1</sup>, Tetsuhiro ASARI<sup>2</sup> And Yuji ISHIYAMA<sup>3</sup>

### SUMMARY

Most types of building damage during the 1995 Hyogo-ken-Nanbu Earthquake were similar to those caused by previous earthquakes, e.g. the damage in the soft first story. One of the features of the damage caused by the earthquake, however, was the mid-story collapse of medium-rise buildings. In this study, elasto-plastic analyses are carried out for MDOF models of various distributions of lateral stiffness and strength in order to investigate such damage. The building is idealized as a MDOF model, which has flexural springs at both ends of each column and the columns can rotate up to 90 degrees which means complete collapse. With this model we can analyze the response of structures subjected to horizontal and vertical motions simultaneously, taking into account  $P - \Delta$  effect. Input earthquake motions used for the analyses are El Centro (1940) and Kobe JMA (1995), etc. Different types of the lateral stiffness distribution are used in the analyses, e.g. (1) uniform stiffness distribution and (2) the stiffness distribution for which the fundamental mode shape is inverted triangular. Different types of the distribution of yield story shear coefficient are also used in the analyses, e.g. (1) Ai distribution of the Japanese code, and (2) the distribution in which the yield story shear coefficients of upper stories are sufficiently large so that the response of the upper stories remains in the elastic range and the response of lower stories exceeds the elastic limit. The analytical results of this study show that the deformation distribution along the height of a building is affected by the input earthquake motion, by the stiffness distribution, and especially by the distribution of yield story shear coefficient. This feature is emphasized for the input earthquake motion recorded during the 1995 Hyogo-ken-Nanbu Earthquake.

### INTRODUCTION

Most types of building damage during the 1995 Hyogo-ken-Nanbu Earthquake were similar to those caused by previous earthquakes, e.g. the damage in the soft first story. One of the features of the damage caused by the earthquake, however, was the mid-story collapse of medium-rise buildings [1]. In Japan, such damage had not been observed until the 1995 Hyogo-ken-Nanbu Earthquake.

In this study, elasto-plastic analyses are carried out for multi-degree-of-freedom (MDOF) models of various distributions of lateral stiffness and strength in order to investigate such damage. At the beginning, the models of four types of stiffness distribution are analyzed. The models of various distributions of strength are also analyzed. Then the models of 1 - 40 stories of various distributions of lateral stiffness and strength are analyzed. Finally single-degree-of-freedom (SDOF) models which represents weak-beam strong-column buildings [2] and soft first story buildings are analyzed. Spectra of maximum yield base shear coefficient when the model collapses are shown. And it is discussed that the spectra of MDOF models of different distribution of lateral stiffness and strength are compared with the spectra of SDOF model which has different collapse mechanism to MDOF models.

<sup>1</sup> Graduate School of Engineering, Hokkaido University., Sapporo, Japan. Email: keiichi@eng.hokudai.ac.jp

<sup>2</sup> Graduate School of Engineering, Hokkaido University., Sapporo, Japan. Email: keiichi@eng.hokudai.ac.jp

<sup>3</sup> Graduate School of Engineering, Hokkaido University., Sapporo, Japan. Email: keiichi@eng.hokudai.ac.jp

## ANALYTICAL MODEL AND PROCEDURE

The analytical model is a MDOF system as shown in Fig. 1. Although the number of the level is counted from the top in Fig. 1 because of mathematical convenience, the story number is counted from the base. The model has hinges with bending springs at both ends of each column and the columns can rotate up to 90 degrees which means complete collapse, therefore it is called a finite rotation model. Using the finite rotation model we can analyze response of structures subjected to horizontal and vertical motions simultaneously, taking into account P- $\Delta$  effect. The natural period T(s) is taken as  $T=0.1N$  where N is the number of stories. The restoring moment of bending hinges is perfect elasto-plastic, however the structure can collapse because of P- $\Delta$  effect. The story height is chosen as 4 meters and the mass distribution is uniform. The fraction of critical damping of the first mode is 0.05.

The input ground motions used for the analyses are listed in Table 1. In this study six records of earthquake motions are used. Although all of these records have two horizontal components, the component which has the larger maximum acceleration is chosen. The horizontal ground motions are adjusted multiplying the factor so that the maximum horizontal velocity becomes 100 cm/s, which may represent very severe earthquake motions. The same factor as the horizontal component is also multiplied to the vertical component. The vertical component is not available for Taft and Fuki. It is confirmed that the vertical component of motion scarcely affects the response of the model for other records.

In the analyses, the yield shear coefficients are gradually decreased until one of the stories comes to collapse.

### INFLUENCE OF LATERAL STIFFNESS DISTRIBUTION

Ten story models with four different types of stiffness distribution along the height are analyzed. Type U has the uniform stiffness distribution, and Type P has the parabolic stiffness distribution, so that the first mode shape is inverted triangular. In order to analyze soft first story building, two types of distribution are assumed. Type U/4 and Type P/4 indicate that the first story stiffness is one-fourth of the second story and the stiffness distribution of upper stories is uniform and parabolic, respectively. For all ten-story models the fundamental natural period is equal to 1.0(s).

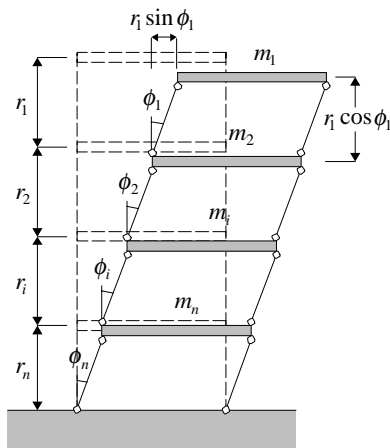

**Fig.1 MDOF model**

**Table 1 Input Ground Motions**

Earthquake record (Year)	Comp.	ID	Max. Accel. (cm/s <sup>2</sup> )	Max. Vel. (cm/s)
El Centro (1940)	NS UD	ElC	341.7 206.3	33.5 12.6
Taft (1952)	EW	Taft	175.9	17.7
Mexico SCT (1985)	EW UD	SCT	167.9 35.7	60.5 9.0
Sylmar (1994)	NS UD	Syl	826.8 525.0	128.9 18.6
Fuki (1995)	N330E	Fuki	802.0	122.8
Kobe JMA (1995)	NS UD	KobeJ	818.0 332.2	90.2 39.9

As to the strength distribution, the distribution of yield story shear coefficients is so called Ai distribution, which is stipulated in the Japanese seismic code. Since other types of strength distribution are also used in the following section, the model is indicated, for example, as Type U-Ai, which means the stiffness distribution is Type U and the strength distribution is Ai.

Figs. 2-1 to 2-6 show the maximum rotational angle of each story in terms of normalized weight until when one story of the model collapses. In these figures,  $C_y$  is the maximum of yield base shear coefficients when one story of the model collapses.

These figures show the first story collapse is most common. For EIC (Fig. 2-1), Taft (Fig. 2-2) and Fuki (Fig. 2-5), all models collapse at the first story. The second story collapse happens in the case of Type P-Ai for SCT (Fig. 2-3), Type U-Ai for KobeJ (Fig. 2-6) and all Types for Syl (Fig. 2-4). This shows almost all models, whose strength distribution is Ai, collapse occurs at the first story regardless of stiffness distribution and the second story collapse occurs in few cases. This indicates that collapse caused by P- $\Delta$  effect occurs at the lower story, although it is said that all stories of Ai distribution have the same probability of damage. This is because P- $\Delta$  effect acts more strongly on lower stories than upper stories.

These figures show that  $C_y$  of Type U is almost equal to that of P and  $C_y$ 's of Type U/4 and P/4 are close.  $C_y$  of U/4 and P/4 is larger than that of U and P, except Syl. In case of Syl (Fig. 2-4),  $C_y$  of models of all types are almost the same. This shows that the building with soft first story need larger base shear coefficient than the buildings whose stiffness distribution is smooth like type U and P.

### INFLUENCE OF LATERAL STRENGTH DISTRIBUTION

In this section analytical results are shown for ten story models with four different types of strength distributions. In many buildings the yield base shear coefficients of upper stories are larger than those stipulated in the code due to minimum requirements of sectional areas of columns, reinforcement ratio, etc. Therefore it is assumed that the yield story shear coefficients of upper stories are sufficiently large and the responses of the upper stories remain in the elastic range and the yield story shear coefficients of lower stories are assumed to be Ai distribution.

The four types of strength distributions are Ai distribution (Type Ai) and lateral shear coefficients of upper three, five and seven stories are sufficiently large (Type E3, E5 and E7, respectively). The strength distribution for lower stories is assumed Ai distribution. The stiffness distribution is assumed to be Type P (parabolic).

Figs. 3-1 to 3-6 show the maximum rotation angles of four types along the height in terms of the normalized weight. Fig. 3-1 and 3-2 show the deformations of Type P-E3, P-E5 concentrate to the story just below the story which behaves elastically, but collapses occur at the lowest story for input ground motion EIC and Taft. Fig.3-3 shows that for SCT the Type P-E7 collapses at the lowest story, the other types collapse at the second story and responses of four types are similar totally. For Syl (Fig.3-4), all models collapse at the second story, and their responses are similar totally. For SCT and Syl (Fig. 3-3 and 3-4), the deformations do not concentrate to the story just below the story that behaves elastically unlike EIC and Taft. The response of Fuki, which is the record of 1995 Hyogo-ken-Nanbu earthquake, is similar to responses by EIC and Taft. But in the case of KobeJ input, which is the record during the same earthquake, the models of P-E5, P-E7 collapse at the story just below the story which behaves elastically. These analytical results of KobeJ coincide with the mid-story collapse of medium-rise during the earthquake.

### $C_y$ SPECTRA

In this section  $C_y$  spectra are shown for models of 1 story to 40 stories (natural period from 0.1(s) to 4.0(s)) with six different types, i.e. U-Ai, P-Ai, U/4-Ep, P/4-Ep, U-Eh and P-Eh. Type Ep has the strength distribution so that only lowest story can behave elasto-plastically and all other stories have sufficient strength and behave elastically. Type Eh is the model in which upper half stories (in case N is odd, upper (N-1)/2 stories) are sufficiently large and elastic, the strength distribution of lower half stories (in case N is odd, lower (N+1)/2 stories) is Ai distribution.

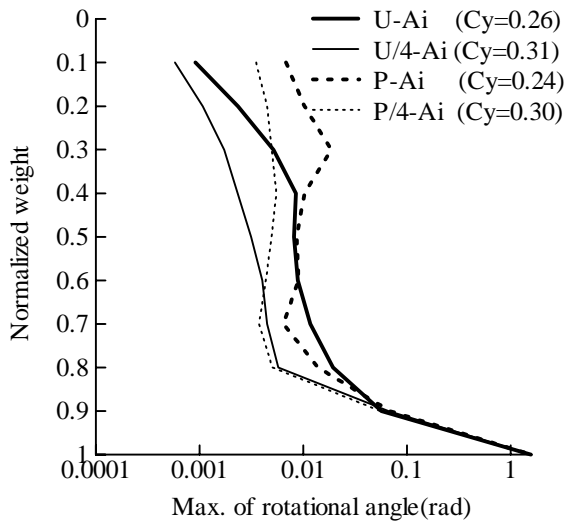

Fig.2-1 Max. of rotational angle (EIC)

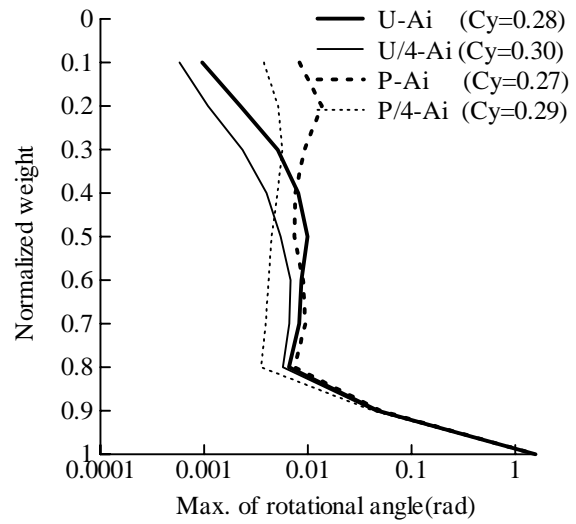

Fig.2-2 Max. of rotational angle (Taft)

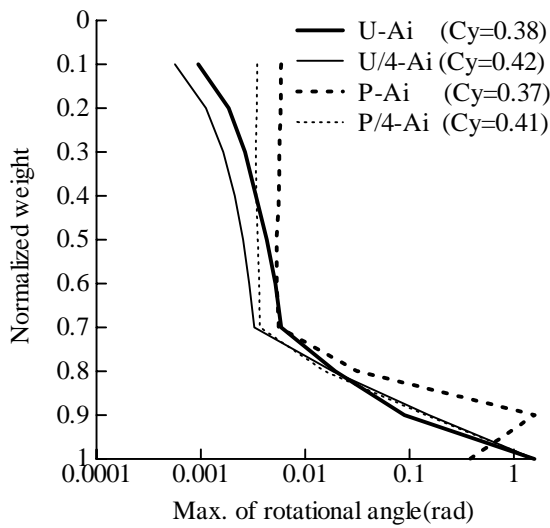

Fig.2-3 Max. of rotational angle (SCT)

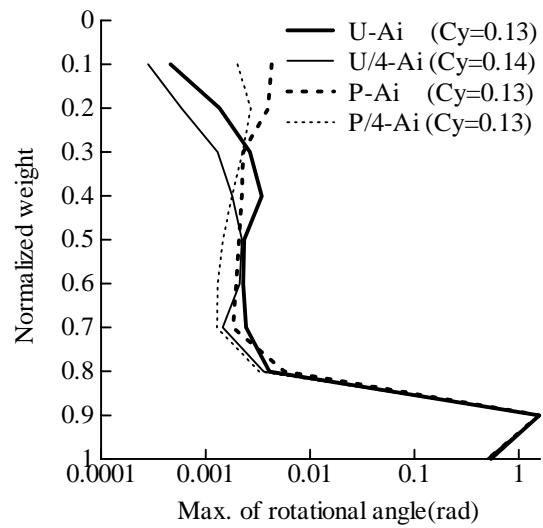

Fig.2-4 Max. of rotational angle (Syl)

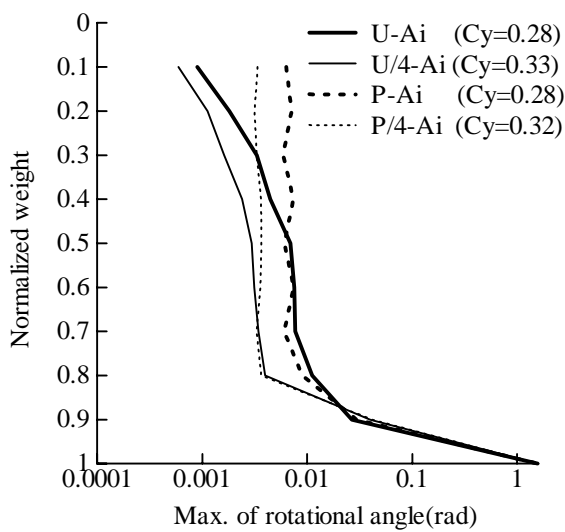

Fig.2-5 Max. of rotational angle (Fuki)

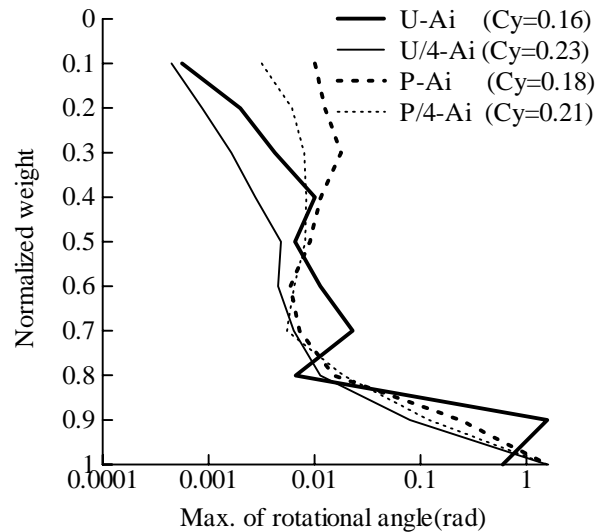

Fig.2-6 Max. of rotational angle (KobeJ)

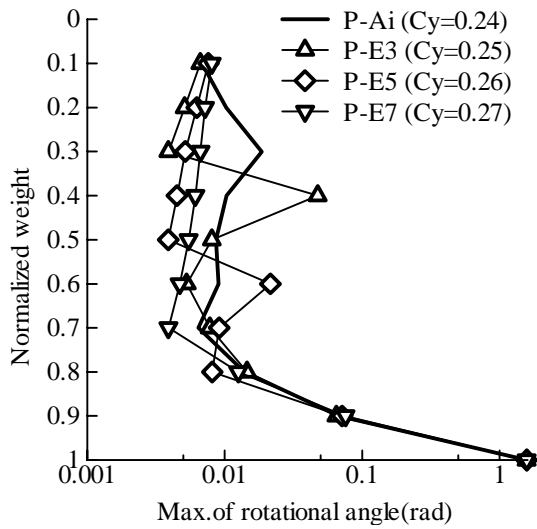

Fig.3-1 Max. of rotational angle (EIC)

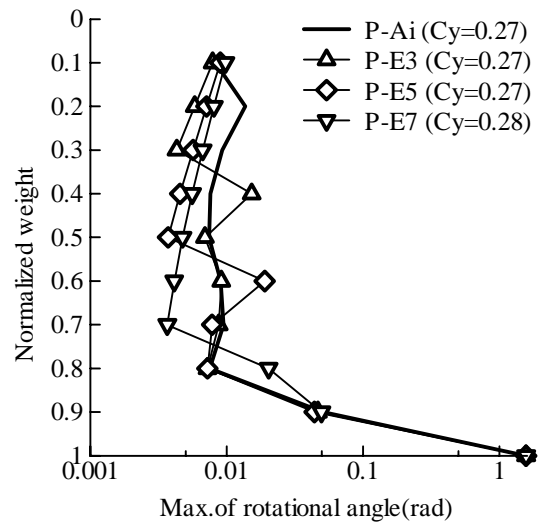

Fig.3-2 Max. of rotational angle (Taft)

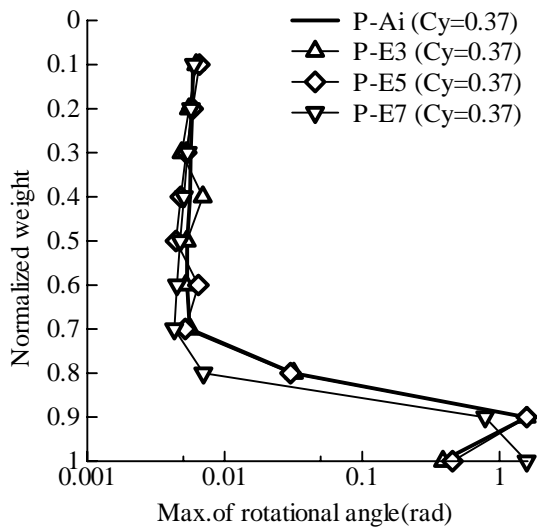

Fig.3-3 Max. of rotational angle (SCT)

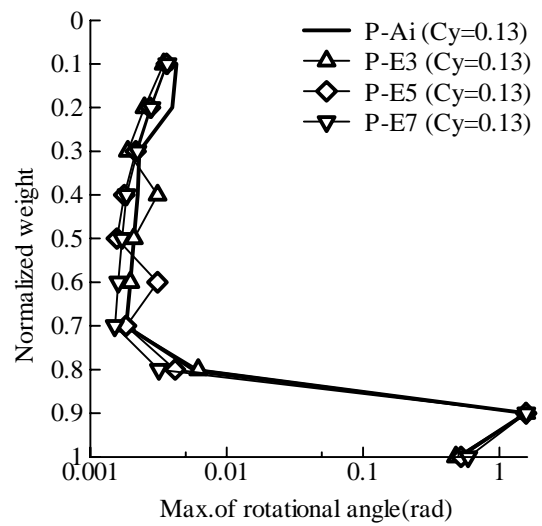

Fig.3-4 Max. of rotational angle (Sly)

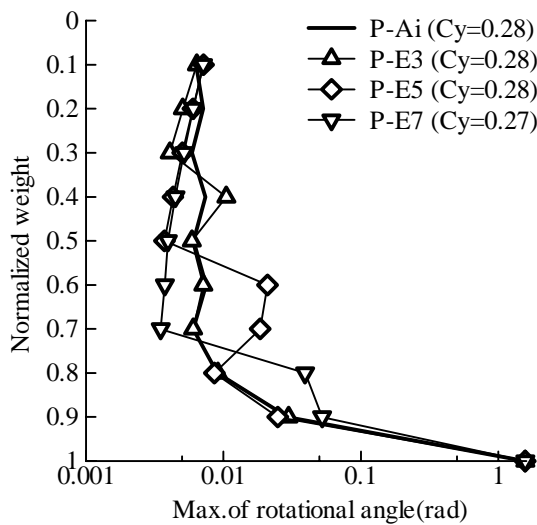

Fig.3-5 Max. of rotational angle (Fuki)

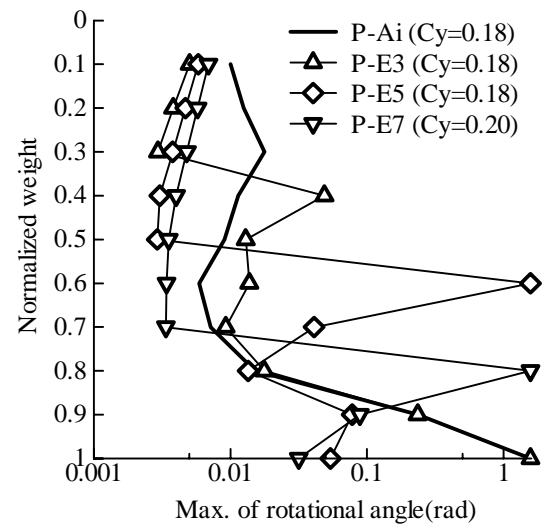

Fig.3-6 Max. of rotational angle (KobeJ)

In order to compare the responses of different types of collapse mechanism models, two types of SDOF models are also analyzed, i.e. weak-beam strong-column model and soft first story model (Fig.4-1 and 4-2).

From the analyses  $C_y$  spectrum is obtained as thick lines in Figs. 5-1 to 5-6. In the Figs, elastic base shear coefficient ( $C_e$ ) spectra are also shown using thin lines. Although  $C_e$  spectra different types of MDOF models differ because of stiffness distribution,  $C_e$  spectrum of MDOF only for Type U is shown in those figures. This is because  $C_e$  spectra of MDOF are almost identical regardless stiffness distributions.

Many MDOF models collapse at the first story regardless of the number of stories. But some models of Types Ai and Eh collapse at the other stories, open circles in Figs. 5-1 to 5-6 indicate the collapse at the story except the first story, which mean in many cases at the second story. Some Type Eh models collapse at the story just below the story which behaves elastically, which is indicated by solid circles.

The figures show  $C_{ym}$  ( $C_y$  of MDOF models) spectra which are indicated by thick dotted lines are very close each other even if stiffness distribution, strength distribution and the collapse story are different.  $C_{ym}$  spectra are also very close to  $C_{yp}$  ( $C_y$  of soft first story SDOF models) spectra. Therefore  $C_{yp}$  is a good approximation to  $C_{ym}$ .

The values of  $C_{yb}$  ( $C_y$  of weak-beam strong-column SDOF models) become smaller as the natural period become longer. The values of  $C_{ym}$  and  $C_{yp}$  are almost constant or become larger as the natural period become longer. This means the design base shear for structures which may behave like the MDOF model or soft first story SDOF model can not be reduced so much as weak-beam strong-column model can for longer natural periods.

The  $C_e$  and  $C_y$  spectra of SCT (Fig. 5-3) become larger at longer period, and the peak of the spectra is 2.0(s). This is because the soil in Mexico City is very soft, then the components of longer periods were amplified. The difference between the  $C_e$  spectra and  $C_y$  spectra of SCT is smaller than those of the other input ground motions. This means that for ground motion as SCT the reduction of design base shear coefficient can be reduced taking into account ductility.

Fig. 5-6 shows the solid circles which means collapse at mid-story of KobeJ are more than those of the other input ground motions (Figs. 5-1 to 5-5), especially at the periods which are equivalent to medium-rise and high-rise building. This corresponds to mid-story collapse of medium rise buildings, which is one of the damage features of structures caused by the 1995 Hyogo-ken-Nanbu Earthquake. There are only few solid circles by Fuki input that is also the record during the 1995 Hyogo-ken-Nanbu Earthquake is input.

Almost all damaged buildings during the 1995 Hyogo-ken-Nanbu Earthquake had been designed according to the old code which had been enforced until 1980. The old code stipulates the distribution of seismic coefficient similar to the uniform distribution, where the distribution is uniform from the top to the base of the building. The lateral strength of the mid-stories and upper stories of buildings designed by the old code are smaller than those of buildings designed by current code. If the uniform distribution of strength is used in the analyses, the mid-story collapse should be more prominent by not only KobeJ input but also by other inputs.

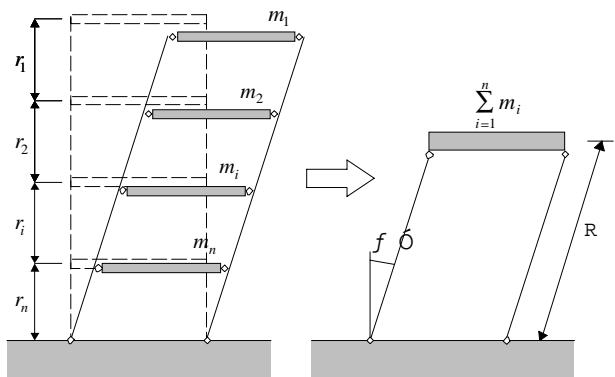

Fig. 4-1 Weak-Beam Strong-column SDOF Model

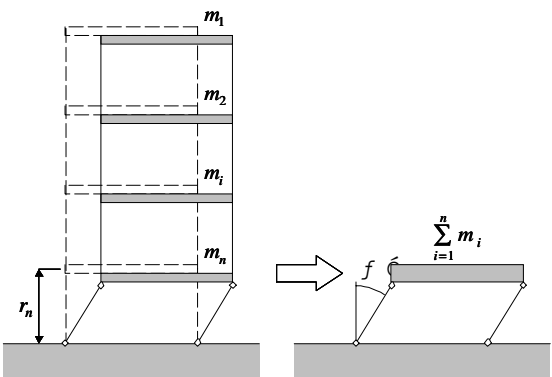
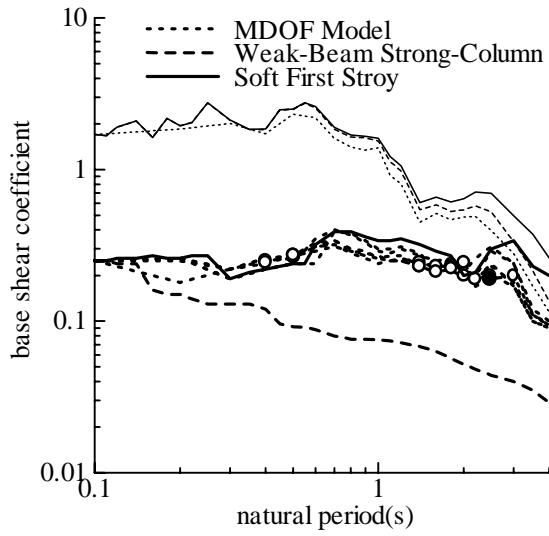
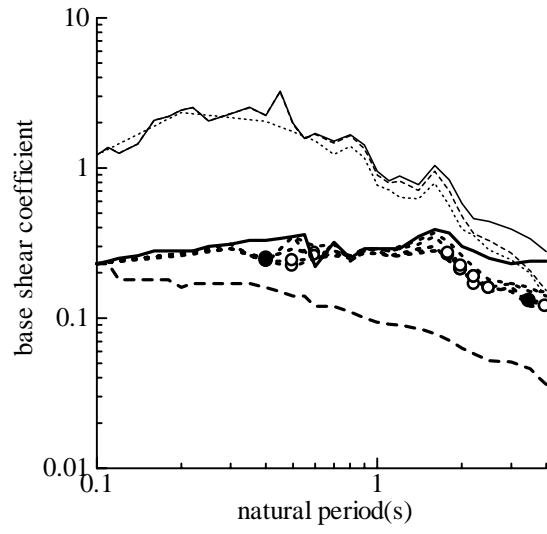

Fig.4-2 Soft first story SDOF Model



**Fig. 5-1** Cy spectra (EIC)



**Fig. 5-2** Cy spectra (Taft)

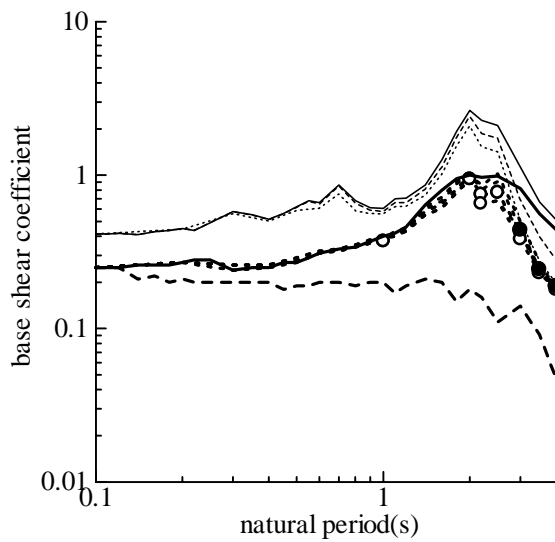

**Fig. 5-3** Cy spectra (SCT)

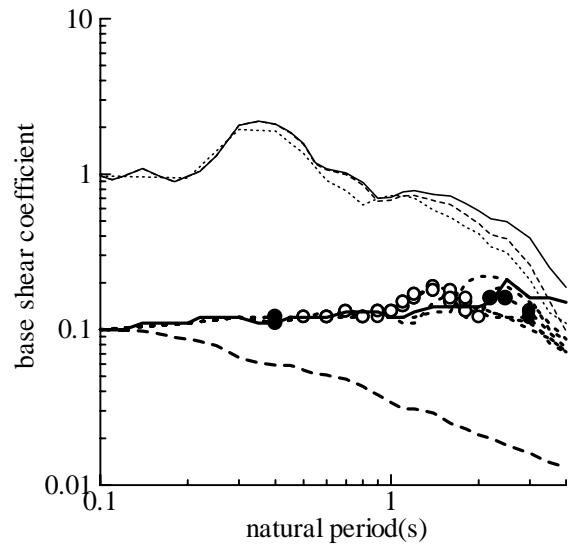

**Fig. 5-4** Cy spectra (Syl)

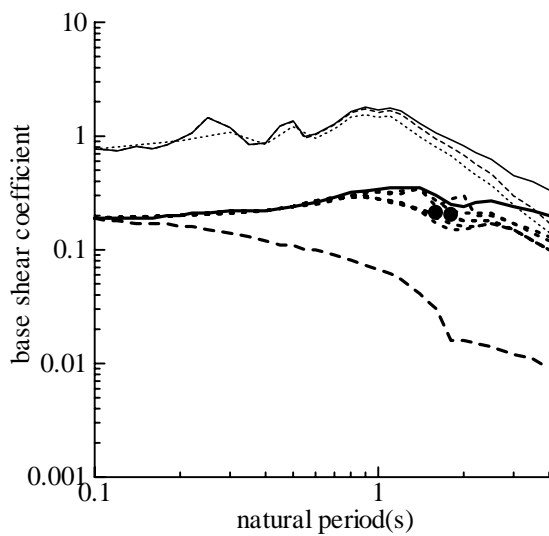

**Fig. 5-5** Cy spectra (Fuki)

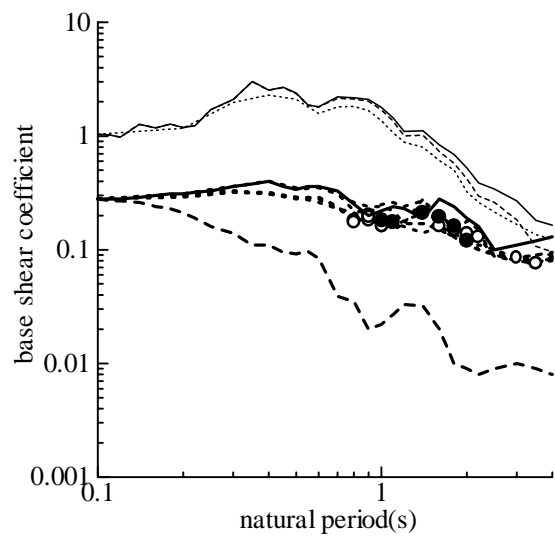

**Fig. 5-6** Cy spectra (KobeJ)

## CONCLUSIONS

In order to investigate the mid-story collapse of the buildings during earthquake, MDOF models of various stiffness and strength distribution are analyzed. The weak-beam strong-column SDOF model and the soft first story SDOF model are also analyzed for comparison. In the analyses, the yield shear coefficients are gradually decreased until one of the stories comes to collapse.  $C_y$  is the maximum of yield base shear coefficients when one story of the model collapses.

As a result, most ten story MDOF models whose strength distribution are Ai collapse at the first story and some models collapse at the second story regardless of stiffness distribution and input ground motions (Figs. 2-1 to 2-6). MDOF models whose yield shear coefficients of upper stories are sufficiently large collapse at the story just below the story which behaves elastically for the input of KobeJ (record during 1995 Hyogo-ken Nanbu earthquake) (Fig. 3-6). For the other ground motions, all models collapse at the first story or at the second story (Figs. 3-1 to 3-5). These results correspond to the damage features of structures caused by the 1995 Hyogo-ken-Nanbu Earthquake.

The values of  $C_{ym}$  ( $C_y$  of MDOF models) are very close each other even if stiffness distribution, strength distribution and the collapse story are different, and the values of  $C_{ym}$  approximate to  $C_{yp}$  ( $C_y$  of Soft first story SDOF models) (Figs. 5-1 to 5-6). The values of  $C_{yb}$  ( $C_y$  of weak-beam strong-column SDOF models) decrease as the natural period become longer. The values of  $C_{ym}$  and  $C_{yp}$  are almost constant or become larger as the natural period become longer. Therefore the design base shear for structures which may behave like the MDOF model or soft first story SDOF model can not be reduced so much as weak-beam strong-column model can for longer natural periods.

$C_y$  spectra have different features for different input ground motions (Figs. 5-1 to 5-6). For SCT (record during 1985 Mexico earthquake) the  $C_y$  spectra become larger at longer period and the difference between the  $C_y$  spectra and the  $C_e$  spectra is smaller than that of the other input ground motions. For KobeJ many MDOF models collapse at mid-story especially at the periods which are equivalent to medium-rise and high-rise building.

## REFERENCE

1. Building Research Institute, Ministry of Construction of Japan, "A Survey Report for Building Damages due to the 1995 Hyogo-ken Nanbu Earthquake "

Ishiyama, Y. and Asari, T., "Extreme of Structural Characteristic Factor to Reduce Seismic Forces due to Energy Absorbing Capacity", *Intl. Workshop on Seismic Design Methodologies for the Next Generation of Codes*, pp.131 – 138, 1997