

Certificate of Calibration

Product Identification

Serial Number: L11257500

Model: JEC-AG
 Part Number: 060-H032-03
 Order Code: AY322HR

Calibration Information

Full Scale Range: +/- 2 INCHES
 Calibration Factor: 2.4390 V/INCH
 Calibration Date: 03/07/2008

Supply: 40 VDC
 Linearity: 0.21 %

Wiring Code

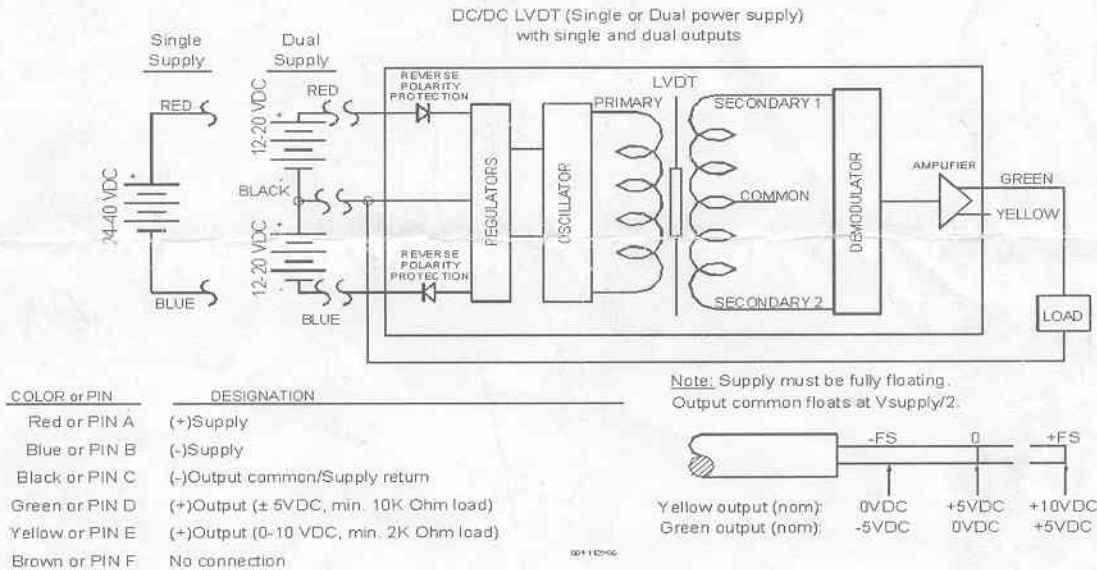

Notes: Instruments used in the calibration of this product have been calibrated to standards traceable to the National Institute of Standards and Technology (NIST). A calibration uncertainty ratio of 4:1 has been maintained unless otherwise stated.

If you have any questions concerning this certificate of calibration, or for recalibration or repair of this product, please visit our website at <http://www.sensotec.com/service.htm> or call our service department at (614) 850-5000.

This is a quality record.

Approved and Certified By: Eszter Gozon
 Eszter Gozon, Quality Manager